

CATALOGUE QUINCAILLERIE

Edition 07/2016

DISQUES ABRASIFS

DISQUE A TRONCONNER EASYWELD / KLINGSPOR



CODE	Dimensions mm	Epaisseur mm	Utilisation	PVHT	PVTTC
ET115X1.6	115 X 22.2	1.6	Inox	1.30	1.56
ET1	125 X 22.2	1.0	Acier / Inox	1.25	1.50
ET1.6	125 X 22.2	1.6	Acier / Inox	1.25	1.50
ET2	125 X 22.2	2.0	Tronçonne et meule	1.94	2.33
ET2.5	125 X 22.2	2.5	Acier / Inox	1.18	1.42
ET5.8	125 X 22.2	6.0	Acier à meuler	1.70	2.04
ET1.9	230 X 22.2	1.9	Acier / Inox	2.70	3.24
ET6.0	230 X 22.2	6.0	Acier à meuler	3.92	4.70
ET300	300 X 25.4	3.0	Acier	8.86	10.63
ET350X3	350 X 25.4	3.0	Acier	10.10	12.12
ET400	400 X 25.4	4.5	Acier	23.44	28.13

DISQUE A TRONCONNER COMET INOX



CODE	Dimensions	PVHT	PVTTC
COT1	125 X 1.0	1.50	1.80
COT1.6	125 X 1.6	1.50	1.80
COT2	230 X 2.0	3.99	4.79

DISQUES A LAMELLES

DISQUES LAMELLES EASYWELD / KLINGSPOR



CODE	Dimensions	Grain	Utilisation	PVHT	PVTTC
EP40	125 X 22.2	40	Acier / Inox	2.86	3.43
EP60	125 X 22.2	60	Acier / Inox	2.86	3.43
EP80	125 X 22.2	80	Acier / Inox	2.86	3.43

DISQUES LAMELLES LUKA



CODE	Dimensions	Grain	PVHT	PVTTC
LUP40	125	40	2.70	3.24
LUP60	125	60	2.70	3.24
LUP80	125	80	2.70	3.24
LUP180	180	40	6.25	7.50

DISQUE DIAMANT

Expert for Universal BOSCH

125 x 22,23 x 2,2 x 12 mm



Le disque universel pour tous les matériaux de construction. La parfaite adéquation entre longévité (hauteur de segment de 12 mm) et performances de coupe garantit un tronçonnage sans problème. Segments de coupe diamantés soudés au laser.

CODE : DDE125

35.00€ HT 42.00€ TTC

ELECTRODES



ELECTRODES EASYWELD MICRO RUTILE 1Kg



CODE	Ø x L (mm)	Conditionnement	PVHT	PVTTTC
ECS2.5	2.5 X 350	1kg	10.83	12.99
ECS3.2	3.2 X 350	1kg	9.23	11.07

ELECTRODES EASYWELD RUTILE 4.5Kg



CODE	Ø x L (mm)	Conditionnement	PVHT	PVTTTC
ELOVER2.5	2.5 X 350	4.5 KILOS	28.33	34.00
ELOVER3.2	3.2 X 350	4.5 KILOS	28.33	34.00

INOX



CODE	Dimensions	Quantité	PVHT	PVTTTC
EL316	2.5	1 KILO	33.12	39.74

CODE	Dimensions	Quantité	PVHT	PVTTTC
EMAGIC	2.5	1 KILO	40.62	48.74

ACCESSOIRES ARC

Pinces porte - électrodes

- WELDARC



Pince porte électrodes à levier, avec mâchoires de pince à 7 positions d'électrode.
Une isolation renforcée au niveau du levier de la pince à souder assure une protection optimale.

CODE	Inten max	Sect max câble	Ø max élec	Poids	PVHT	PVTTC
WEL300	300 A	50 mm ²	4.0 mm	390g	13.00	15.60

- PREMIUM



Pince porte électrodes à vis, avec mâchoire de pince à une position d'électrode.
L'isolation renforcée au niveau de la tête de la pince à souder garantit une protection sûre.

CODE	Inten max	Sect max câble	Ø max élec	Poids	PVHT	PVTTC
PRE400	400 A	50 mm ²	6.3mm	450g	17.76	21.31

Prises de masse



Les pinces de la gamme CROCO sont des prises de masse type crocodile en laiton moulé.
Constituées de mâchoires avec dents pour une meilleure accroche sur pièces de différentes formes.

CODE	Inten max	Sec max câble	Poids	PVHT	PVTTC
CRO300	300 A	35 mm ²	290g	13.56	16.27
CRO400	400 A	50 mm ²	380g	13.68	16.42

ACCESSOIRES DE SOUDURE

POSITIONNEMENT

KIT DE 2 MINI-MAGNETS

Angles 30°/60° - 45°/90°

CODE : EMO

13.50 € HT **16.20 € TTC**



EQUERRE MAGNETIQUE

Permet le positionnement de tubes ronds, carrés et de pièces plates .

Angles 45°/90°

Force : **36 Kg**

CODE : EMA

32.61 € HT **39.13 € TTC**



EQUERRE MAGNETIQUE

Angles 45°/90°

Force: **65 Kg**

CODE : EMU

57.50€ HT **69.00€ TTC**



ACCESSOIRES DE SOUDURE

POSITIONNEMENT

SERRE - JOINT TUBE

Serre-joint ajustable pour tubes ronds
Acier chromé
Capacité de serrage tube Ø38 à 76 mm

CODE : SJT

28.80 € HT **34.56 € TTC**



SERRE - JOINT D'ANGLE

Permet de serrer des angles droits et des angles en T.
Le réglage du serrage de la tête s'effectue à partir de la poignée.
Acier chromé

CODE : SJA

39.56 € HT **47.47 € TTC**



ETAU 3 AXES

Positionnement de 3 tubes simultanément
L'étau et le bras articulé permettent un serrage efficace et rapide grâce à des boutons poussoirs

CODE : ETAU3

190.00 € HT **228.00 € TTC**

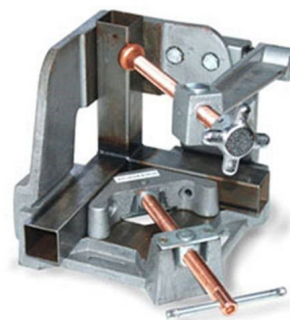

MASQUES DE SOUDURE ELECTRONIQUES

CODE : MELECP 62.50€ HT 75.00€ TTC

Masque **SHINE**



Code : EC103 Inter Dimensions **103.5X47** 1.83€ HT 2.20€ TTC

Code : EC110 Exter Dimensions **110X90** 1.92€ HT 2.30€ TTC

CODE : MELEC1 87.50€ HT 105.00€ TTC

Masque **SPARK EW**

Qualité optique 1/3/1/2 - Cellule 2 capteurs
Champ de vision 97x47mm - Réglage intérieur de la teinte variable 4/9-13
Réglage de la sensibilité - Réglage du délai de retour à la teinte claire
Position meulage - Solaire
Utilisation : ARC-MIG/MAG-TIG A PARTIR DE 30A



Code : EC105 Inter Dimensions **105X54** 1.83€ HT 2.20€ TTC

Code : EC110 Exter Dimensions **110X90** 1.92€ HT 2.30€ TTC



CODE : MELEC2 99.17€ HT 119.00€ TTC

Masque **TWILIGHT**

Qualité optique 1/1/1/2 - Cellule 4 capteurs
Champ de vision 97x47mm - Réglage intérieur de la teinte variable 4/9-13
Réglage de la sensibilité - Réglage du délai de retour à la teinte claire
Position meulage - Solaire
Utilisation : ARC-MIG/MAG-TIG A PARTIR DE 5A



Code : EC105 Inter Dimensions **105X54** 1.83€ HT 2.20€ TTC

Code : EC110 Exter Dimensions **110X90** 1.92€ HT 2.30€ TTC

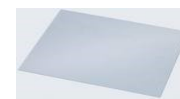

CODE : MELEC3 107.50€ HT 129.00€ TTC

Masque **BLITZ**

Qualité optique 1/1/1/2 - Cellule 4 capteurs
Champ de vision 100x60mm - Réglage intérieur de la teinte variable 4/9-13
Réglage de la sensibilité - Réglage du délai de retour à la teinte claire
Position meulage - Solaire
Utilisation : ARC-MIG/MAG-TIG A PARTIR DE 5A



Code : EC106 Inter Dimensions **106X66** 1.98€ HT 2.38€ TTC

Code : EC114 Exter Dimensions **114X33** 3.81€ HT 4.57€ TTC



CODE : BAND Sachet 2 bandeaux anti-sueur pour serre-tête 4.17€ HT 5.00€ TTC

CODE : STMAG Serre-tête Magic weld 12.00€ HT 14.40€ TTC

Poste à souder MMA ProArc 140 EasyWeld

**WELD
IN
BLACK**



Le **poste à souder** onduleur MMA **ProArc 140** d'EasyWeld est conçu pour souder en courant continu tous les types d'électrodes.

Il est équipé d'une position TIG (liftarc).

Livré avec accessoires ARC.

Caractéristiques techniques

Alimentation	V	220 50/60 Hz 1ph		
Consommation à 70 %	KVA	6		
Courant de soudage	A	10÷140		
Tension à vide	V	63		
Facteur de marche (cycle de 10' à 40°C)	A	35%140 100% 83	Diamètre électrode	mm 1.6 ÷ 3.2
			Classe d'isolation	F
Indice de protection		IP21		
Dimensions LxH	mm	313x130x250		
Poids	Kg	4.7		

CODE : ARC140

216.67€ HT

260.00€ TTC



ProArc 160



Caractéristiques techniques		
Alimentation	(1 ph)	230 V 50/60 Hz
Consommation	KVA	7.11
Tension à vide	V	63
Courant de soudage	A	10 - 160
Facteur de marche		35 % 160
	A	
(cycle de 10' à 40°C)		100 % 95
Diamètre électrode	mm	1.6 - 4.0
Indice de protection		IP21
Classe d'isolation		F
Dimensions	mm (LxH)	313 x 130 x 250
Poids	Kg	4.7
Réf 1EW003		

L'onduleur ProArc 160 est conçu pour souder en courant continu tous les types d'électrodes : rutiles, basiques, inox ... Grâce à sa fonction anti-collage, l'amorçage et le soudage deviennent très faciles.

Une grande stabilité de l'arc et une fusion douce caractérisent ce matériel.

Le poste est équipé d'une position TIG (liftarc).

Livré avec :

- câble d'alimentation avec sa prise mono 16A,
- câble pince porte électrode,
- câble pince de masse,
- mallette de rangement ABS

CODE : ARC160

275.00€ HT

330.00€ TTC

Poste à souder MMA ProArc 180 PFC EasyWeld

**WELD
IN
BLACK**



Le **poste à souder** onduleur MMA **ProArc 180 PFC** d'EasyWeld est conçu pour souder en courant continu tous les types d'électrodes.

Il est équipé d'une position TIG (liftarc).

Livré avec accessoires ARC et une mallette de rangement ABS.

Caractéristiques techniques

Alimentation	V	220 50/60 Hz 1ph		
Consommation à 70 %	KVA	9.4		
Courant de soudage	A	10÷180		
Tension à vide	V	66		
Facteur de marche (cycle de 10' à 40°C)	A	35% 180 100% 118	Diamètre électrode	mm ÷ 5.0
			Classe d'isolation	F
Indice de protection		IP21		
Dimensions LxlxH	mm	313x130x250		
Poids	Kg	5.2		

CODE : ARC180

383.33€ HT

460.00€ TTC



ProMig 180

WELD IN BLACK



Onduleur MIG/MAG (gaz/sans gaz), bobine de fil Ø 200 mm, galets 0,6 à 1,0 mm. Livré avec une torche MIG 150A.

MODÈLE	PROMIG 180	
ALIMENTATION	230V 50/60 Hz 1 ph	
CONSOMMATION KVA	7,1	
TENSION À VIDE V	53	
	MMA	MIG
COURANT DE SOUDAGE A	10÷160	10÷180
FACTEUR DE MARCHE A (CYCLE 10' À 40°C)	35% 160 100% 95	35% 180 100% 106
DIAMÈTRE ÉLECTRODE / FIL EN MM	1,6 ÷ 5,0	0,6 - 1,0
CLASSE D'ISOLATION	F	
INDICE DE PROTECTION	IP21	
DIMENSIONS MM LXLXH	485 x 185 x 370	
POIDS KG	12,5	
RÉFÉRENCE	1EW159	

CODE : COMBI180 908.33€ HT 1090.00€ TTC



Tube contact MB15 M6 D 1.0



Buse conique MB15

CODE : BU 2.80€ HT 3.36€ TTC

BOBINE FIL A SOUDER



FIL MAG
Acier ER 70S6

Propriétés et applications

Fil massif d'usage général pour le soudage des aciers courants de construction. S'utilise sous protection gazeuse (Argon+CO2) en polarité positive.

Industrie automobile, constructions métalliques, serrurerie, mécano-soudure...

CODE	Diamètre	Bobine	PVHT	PVTTC
BFIL5K	Ø 0.8	Ø 200mm - 5 Kg	18.15	21.78
BFIL0.8	Ø 0.8	Ø 300mm - 15 Kg	39.60	47.52
BFIL1.0	Ø 1.0	Ø 300mm - 15 Kg	36.45	43.74



Fil fourré sans gaz

Propriétés et applications

Fil fourré sans gaz pour soudage sur chantier Utilisation en polarité négative. Assemblage de tôles ou profilés, soudage de ronds à béton.

CODE	Diamètre	Bobine	PVHT	PVTTC
BFOU	Ø 1.0	Ø 200mm - 5 Kg	40.50	48.60

SANGLE D'ARRIMAGE



SANGLE ARRIMAGE

- Largeur **25mm**
- Longueur **5M00**
- Résistance à la rupture : **800 kg**

Code : S5M 5.68 € HT **6.82 € TTC**



SANGLE ARRIMAGE

- Largeur **35mm**
- Longueur **5M00**
- Résistance à la rupture : **1T500**
- 2 crochets doubles

Code : S535 12.92€ HT **15.50 € TTC**



SANGLE ARRIMAGE

- Largeur **50mm**
- Longueur **9M00**
- Résistance à la rupture : **5Tonnes**
- 2 crochets bord de rive

Code : S9M 13.38 € HT **16.06 € TTC**



SANGLE ARRIMAGE

- Largeur **50mm**
- Longueur **12M00**
- Résistance à la rupture : **5Tonnes**
- 2 crochets bord de rive

Code : S12M 19.22 € HT **23.06 € TTC**



SANGLE AUTOMATIQUE

- Largeur **25mm**
- Longueur **3M00**

Code : SAUTO 16.58 € HT **19.90€ TTC**



SANDOW CROCHET (tendeur)

Code : SANDCRO 4.10 € HT **4.92 € TTC**

AEROSOLS

ANTI-ADHERENT GRATTONS

Aérosol 650ml



Code : 3A

4.32 € HT

5.18 € TTC

Pour la protection des buses et des pièces soudées.

Ce produit est simple à mettre en œuvre : pulvériser en tenant l'aérosol à 20 cm de distance, appliquer soit sur les buses froides, ou éventuellement préchauffées. Cette formulation a été réalisée sans solvant sur base aqueuse et garantit donc les opérateurs d'aucune émission de vapeur toxique.

Il n'oxyde pas les pièces métalliques, permet les reprises sans défaut d'aspect, il ne génère pas de craque. Il n'encrasse pas, ne pollue pas.



AEROSOL GALVA BRILLANT 650ml

Code : BGB

7.50 € HT

9.00 € TTC



LUBRIFIANT / DEGRIPPANT WD40 Systeme Pro 500 ml

5 Fonctions :

- dégrissant,
- anti-humidité,
- anticorrosion,
- lubrifiant,
- nettoyant.

Code : DEGRI

7.17€ HT

8.60€ TTC



BOMBE MARQUAGE FLUO

Code : BFLUO

5.00 € HT

6.00 € TTC



Aérosol huile de coupe

Code : AHUI

10.00 € HT

12.00 € TTC



Bidon huile de coupe 5 Litres

Code : HUILE

37.50 € HT

45.00 € TTC

VERNIS / PEINTURE

VERNIS INCOLORE



CODE	DESIGNATION	PVHT	PVTTTC
EASYS	Vernis antirouille / Satiné / 1 Litre	29.74	35.69

PEINTURE Bidon 5kilos



CODE	DESIGNATION	PVHT	PVTTTC
PEINTN	Laque teinte et métal NOIR	81.67	98.00
PEINTM	Laque teinte et métal MARRON	81.67	98.00
PEINTV	Laque teinte et métal VERT	81.67	98.00
PEINTG	Laque teinte et métal GRIS	81.67	98.00

PEINTURE aérosol







CODE	DESIGNATION	PVHT	PVTTTC
BOMBE	Topspray 400ml Différents RAL	11.25	13.50

SERRURES / POIGNÉES

	<p>CODE : SMATCHD Serrure Horiz petite clé / 4 clés / carré 6 DROITE</p> <p>CODE : SMATCHG Serrure Horiz petite clé / 4 clés / carré 6 GAUCHE</p>	32.40	38.88
	<p>CODE : P.BOU Poignée bouton double ornée fonte laquée noire Carrée de 6 Longueur de 55 à 75</p>	5.50	6.60
	<p>CODE : PBOU2 Poignée bouton double ornée fonte grise / carré de 6 / longueur de 55 à 90</p>	9.41	11.29
	<p>CODE : PBAL Bouton alu ovale époxy noir carré de 6</p>	6.50	7.80
	<p>CODE : PNOIR Poignée béquille alu époxy noir carré de 6 ou de 8 Longueur de 55 à 90</p>	7.00	8.40
	<p>CODE : POG140 Poignée forgée ronde [8]mm 80x140</p>	20.42	24.50
	<p>CODE : PO120P Poignée forgée plate [8]mm 80x120</p>	20.42	24.50

SERRURES / CYLINDRES

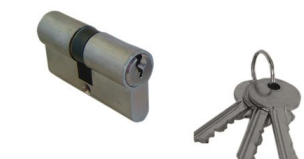
	CODE / DESCRIPTIF	PVHT	PVTTC
 	<p><u>ATTENTION SERRURE SANS CYLINDRE</u></p> <p>CODE : SMET21 Pene dormant et 1/2 tour</p> <p>CODE : SMET28 Pene dormant et 1/2 tour</p> <p>CODE : CYL28 Cylindre 30X30 Européen 5 goupilles Nikele Panneton PM12</p>	<p>38.58</p> <p>42.32</p> <p>17.95</p>	<p>46.30</p> <p>50.78</p> <p>21.54</p>
 	<p><u>ATTENTION SERRURE SANS CYLINDRE</u></p> <p>CODE : SMET7.36 Coffre serrure 1/2T 7/36</p> <p>CODE : CYL30 Cylindre 30X30 5 goupilles ECO PRO laiton poli varie</p>	<p>24.38</p> <p>6.95</p>	<p>29.26</p> <p>8.34</p>
 	<p><u>ATTENTION SERRURE SANS CYLINDRE</u></p> <p>CODE : S3P Serrure 3 points Stremler + jeu tringles complet</p> <p>CODE : CYL30 Cylindre 30X30 5 goupilles ECO PRO laiton poli varie</p>	<p>107.50</p> <p>6.95</p>	<p>129.00</p> <p>8.34</p>

SERRURERIE

	CODE / DESCRIPTIF	PVHT	PVTTC
	CODE : SCRO Serrure à crochet (<i>sans cylindre</i>)	22.29	26.75
	CODE : GSCRO Gâche plate	3.67	4.40
	CODE : ASCRO Anneau double en bronze d'aluminium + Fourreau laiton	18.51	22.21
	CODE : BSCRO Boîte pour serrure à crochet (<i>sans cylindre</i>)	9.44	11.33
	CODE : CYL28 Cylindre 30X30 Européen 5 goupilles Nikele Panneton PM12	17.95	21.54
	CODE : CYL30 Cylindre 30X30 5 goupilles ECO PRO laiton poli varie	6.95	8.34



SERRURE A CROCHET COULISSANT TUBE 40

CODE : SC40

50.00€ HT

60.00€ TTC

SERRURES Spéciales

SERRURE 3 POINTS A2P PERFECTA

Tringlerie télescopique réglable

Mécanisme en acier chromé.
Equerre au demi-tour, pènes dormants,
18 mm de diamètre.
Course des pènes : 40 mm.
Cylindre 6 goupilles.
Anti-perçage, anti-crochetage pour porte
de 45 mm. Longueur : 50 mm.
Bague tournante anti-arrachement en acier traité.
Diamètre : 33 mm.
Hauteur maximum : 2 660 mm.



CODE :	PERFD	70.83€ HT	85.00€ TTC
	PERFG		

SERRURE ANTI-PANIQUE IDEA PUSH BOLT

Norme NF EN 1125:2008.
Résistance à l'effraction 2 tonnes.

Résistance à la corrosion : 240 heures.
Endurance > 200 000 ouvertures.
Barre de 840 mm en standard recoupable jusqu'à 330 mm.
Profil étroit 37 mm permettant la pose sur tout type de support.
Hauteur : 2400 mm. Pènes haut et bas cylindriques tournant
anti-sciage (diamètre 14 mm).
Ces pènes sont rétractables et se réarment automatiquement.
Coupe-feu avec l'utilisation des gâches haute et basse platine à
l'exclusion de toute autre.



SERRURES DE PISCINE



CODE : BSKID

BOUTON DE SECURITE KIDLOC 3006WS [LOCINOX](#)
pour serrures et portillons - Carré de 8
Conforme à la norme de sécurité piscine

Prix HT : 23.33€ **Prix TTC : 28.00€**



CODE : LOC40N (noire) LOC40B (blanche)

SERRURE PISCINE [LOCINOX](#) TWIST40

Prix HT : 54.35€ **Prix TTC : 65.22€**



CODE : SWING40

CHARNIERE A RESSORT POUR PROFILS DE 40x40

Prix HT : 45.99€ **Prix TTC : 55.19€**



CODE : STREMP (poignée plastique)

SERRURE PISCINE [STREMLER](#) 36mm
AFNOR P90-306

Prix HT : 100.00€ **Prix TTC : 120.00€**



CODE : SPISCINE (Tête inox)

SERRURE PISCINE [STREMLER](#) 36mm
AFNOR P90-306



Prix HT : 112.50€ **Prix TTC : 135.00€**

VERROUS

	CODE / DESCRIPTIF	PVHT	PVTTC
	CODE : VER10 Verrou porte cadenas D10mm Galva	2.72	3.26
	CODE : VER12 Verrou porte cadenas D12mm Galva	2.82	3.38
	CODE : VER14 Verrou porte cadenas D14mm Galva	3.60	4.32
	CODE : VER16 Verrou porte cadenas D16mm Galva	3.98	4.78
	CODE : VAD16 Verrou à douille 16x300 Epoxy noir	4.50	5.40
	CODE : VB16 VERROU A SOUDER OU A VISSER BRUT 16X300	8.40	10.08
	CODE : BOX16 VERROU BOX BRUT A SOUDER OU A VISSER 16X160	7.00	8.40
	CODE : PISTO16 VERROU PISTOLET A VISSER OU A SOUDER BRUT 16X180	7.00	8.40
	CODE : VBOU VERROU 5G à bouton 4 Clés Longueur cylindre 45mm	35.00	42.00
	CODE : V2E VERROU 5G à 2 entrées 4 Clés Longueur cylindre 45mm	40.00	48.00

ACCESSOIRES

	CODE / DESCRIPTIF	PVHT	PV TTC
	CODE : APC Angle pare-close	1.60	1.92
	CODE : CLIPAR Attache rapide pare close	0.40	0.48
	CODE : VISPAR Vis parclose 4x12	0.34	0.41
	CODE : SUPRAMP Support de rampe	3.50	4.20
	CODE : EQ80 Equerre acier 80X80 Ø12	4.18	5.02
	CODE : AGB Arrêt de grille à bascule	23.63	28.36
	CODE : SANOIR Sabot de portail noir	18.47	22.16
 Epaisseur 4mm 140 x 85	CODE : 19231 Sabot portail à visser H.45	9.00	10.80
 Epaisseur 4mm 160 x 50	CODE : 19241 Sabot de portail à sceller	10.00	12.00

RAILS				
	CODE		PRIX HT	PRIX TTC
	RAU16	Rail à visser gorge U - Ø16 Ep.3mm l.56mm - L3000	17.00	20.40
	RAU20 New*	Rail à visser gorge U - Ø20 Ep.3mm l.56mm - L3000	30.82	36.98
	RAILV	Rail à visser gorge V - L3000	21.98	26.38
	RSCEL	Rail à sceller gorge ronde - Ø16 l.40 x h.50 L3000	30.00	36.00

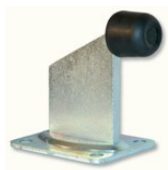
	CODE		PRIX HT	PRIX TTC
	AFC	Arrêt de fin de course pour coulissant H.92.5	5.00	6.00
	BPP	Butée de portail sur platine de 100x80 / H.93.5	6.00	7.20



PATTE A SCELLER			
CODE		PRIX HT	PRIX TTC
PSCEL50	Pour rail 50X40	1.26	1.51
PSCEL62	Pour rail 62X55	3.04	3.65
PSCEL85	Pour rail 85X72	5.36	6.43



PATTE EQUERRE A VISSER			
CODE		PRIX HT	PRIX TTC
PVIS3533	Support rail 35X33	1.00	1.20
PVIS5040	Support rail 50X40	1.58	1.90
PVIS6255	Support rail 62X55	3.16	3.79



OLIVE			
CODE		PRIX HT	PRIX TTC
OLIV30	Diamètre 30 / H 40.5	3.60	4.32
OLIV40	Diamètre 40 / H 58.5	4.82	5.78
OLIV40JT	Olive nylon D40X60 M16 AVEC JOINT	7.60	9.12



PLAQUE GUIDE REGLABLE			
CODE		PVHT	PVTTC
PGR2	Pour 2 olives Ø 30	8.10	9.72
PGR4	Pour 4 olives Ø 30	16.20	19.44



PATTE			
CODE		PVHT	PVTTC
PF270	Patte fixation à sceller 270 x 35 Ep 6mm	3.00	3.60
EQ	Patte guide olive à visser	8.06	9.67



SUPPORT POUR CHEMIN DE ROULEMENT GALVA TIGE LONGUE			
CODE	DIMENSION	PRIX HT	PRIX TTC
SUP30	30X35X1,5	3.44	4.13
SUP50	50X40X2	3.82	4.58
SUP62	62X55X2	5.92	7.10
SUP85	85X70X2	13.44	16.13



MANCHONS POUR RAIL			
CODE	DIMENSION	PRIX HT	PRIX TTC
MANCH30	TIGE 10X100 RAIL 35X30	9.10	10.92
MANCH50	TIGE 12X120 RAIL 50X40	10.37	12.44
MANCH62	TIGE 14X120 RAIL 62X55	11.64	13.97
MANCH85	TIGE RAIL 85X70	27.55	33.06



CHEMIN DE ROULEMENT GALVA (Barre de 6m)			
CODE	DIMENSION	PRIX HT	PRIX TTC
CHRG30	30X35X1,5	19.22	23.06
CHRG50	50X40X2	32.44	38.93
CHRG62	62X55X2	39.53	47.44
CHRG85	85X70X3	76.65	91.98



MONTURE POUR FIXATION			
CODE	DIMENSION	PRIX HT	PRIX TTC
MPF30	35X30 Force 40 kgs	14.70	17.64
MPF50	50X40 Force 75 kgs	19.44	23.33
MPF62	62x55 Force 150 kgs	29.98	35.98
MPF80	85x70 Force	63.82	76.58

PIVOTS DE PORTAIL

PIVOT DE PORTAIL POUR TUBE CARRE 35X35

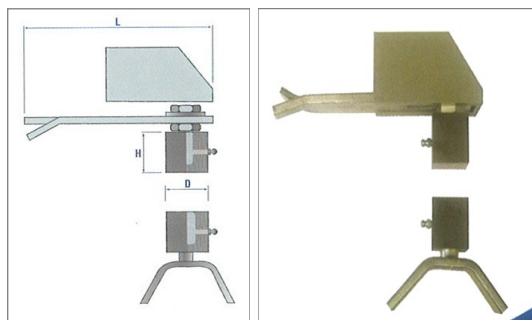

CODE : PIV35

Prix HT : 15.01 €

Prix TTC : 18.01 €

PIVOT DE PORTAIL POUR TUBE CARRE 40X40

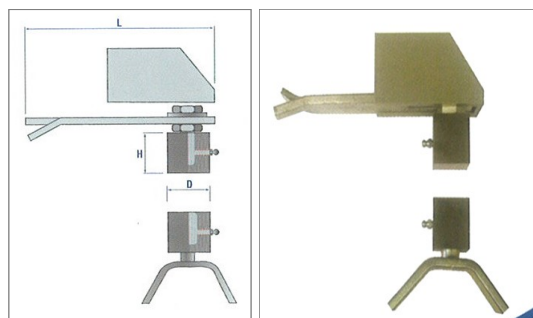

CODE : PIV40

Prix HT : 16.06 €

Prix TTC : 19.27 €

PIVOT A SCELLEMENT CHIMIQUE POUR TUBE CARRE 40X40



CODE : PIVSCEL

Prix HT : 20.83 €

Prix TTC : 25.00 €

ACCESSOIRES POUR PORTAIL

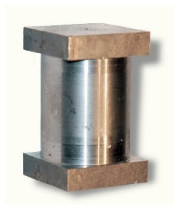

AXE POUR TUBE 40mm

CODE : A40

Prix HT : 8.00 €

Prix TTC : 9.60 €



Gond sur platine M20 à visser réglable (100x100)

CODE : PIV1

Prix HT : 15.44 €

Prix TTC : 18.53 €

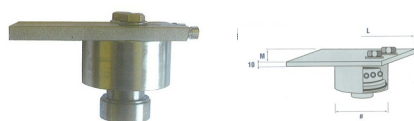

PIVOT SUPERIEUR A BILLE

CODE : PIV3

Prix HT : 30.00 €

Prix TTC : 36.00 €

Accessoires Volet / Porte



Gond à sceller 2 lames 35X5X120 D14

Code : G14

2.82€ HT

3.38€ TTC

***Gond à sceller 2 lames 35X5X120 D16**

Code : G16

3.88€ HT

4.66€ TTC



Nœud à souder penture D14

Code : PENT14

2.56€ HT

3.07€ TTC

Nœud à souder penture D16

Code : PENT16

2.64€ HT

3.17€ TTC



Penture coudée percée 35x5 Noir 600 Ø14

Code : PENT35

7.54€ HT

9.05€ TTC

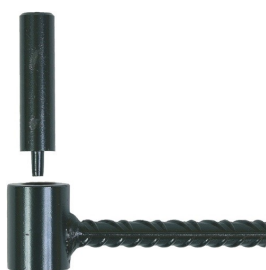

Gond parpaing fer à béton 10X8 D14

Code : GSCEL14

6.74€ HT

8.09€ TTC

PAUMELLES

• PAUMELLE MAROC à souder

CODE	TAILLE	PRIX HT	PRIX TTC
PAUM60	60	0.70	0.84
PAUM80	80	1.40	1.68
PAUM100	100X8 100X11	1.60	1.92
PAUM120	120	2.12	2.54
PAUM140	140	3.22	3.86
PAUM160	160	3.58	4.30

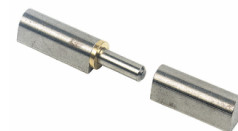

• PAUMELLE MAROC à souder à billes

CODE	TAILLE	PRIX HT	PRIX TTC
PAUMBAB120	120	2.18	2.62



• PAUMELLE LAME COURTE à souder

CODE	TAILLE	PRIX HT	PRIX TTC
PAUMC80	80	2.40	2.88
PAUMC100	100	3.90	4.68
PAUMC120	120	4.74	5.69
PAUMC140	140	5.10	6.12



• PAUMELLE DE GRILLE LEGERE

CODE	TAILLE	PRIX HT	PRIX TTC
PA100	100	3.90	4.68



TIGES FILETEES GALVA EN 1M00



CODE	DIMENSION	PRIX HT	PRIX TTC
TFG6	6	0.54	0.65
TFG8	8	0.93	1.12
TFG10	10	1.50	1.80
TFG12	12	2.15	2.58
TFG14	14	2.95	3.54
TFG16	16	3.90	4.68
TFG18	18	5.25	6.30
TFG20	20	5.79	6.95
TFG22	22	7.34	8.81
TFG24	24	8.18	9.82
TFG27	27	10.88	13.06

ECROUS



CODE	Dimension	PRIX HT	PRIX TTC
ECR6	6	0.03	0.04
ECR8	8	0.05	0.06
ECR10	10	0.08	0.10
ECR12	12	0.12	0.14
ECR14	14	0.13	0.16
ECR16	16	0.18	0.22
ECR18	18	0.30	0.36
ECR20	20	0.39	0.47
ECR22	22	0.69	0.83
ECR24	24	0.84	1.01
ECR27	27	1.20	1.44

RONDELLES M



CODE	Dimension	PRIX HT	PRIX TTC
RL6	M 6	0.03	0.04
RL8	M 8	0.03	0.04
RL10	M 10	0.05	0.06
RL12	M 12	0.08	0.10
RL14	M 14	0.09	0.11
RL16	M 16	0.10	0.12
RL18	M 18	0.12	0.14
RL20	M 20	0.16	0.19
RL22	M 22	0.20	0.24
RL24	M 24	0.32	0.38
RL27	M 27	0.40	0.48

VIS AUTOPERCEUSES (FER)



CODE	DIMENSION	PRIX HT A L'UNITÉ	PRIX TTC A L'UNITÉ	PRIX HT LES 100	PRIX TTC LES 100
VAP6.3X25	6,3 X 25	0.12	0.14	12.00	14.40
VAP6.3X32	6,3 X 32	0.14	0.17	14.00	16.80
VAP6.3X50	6,3 X 50,8	0.18	0.22	18.00	21.60
VAP6.3X60	6,3 X 60	0.20	0.24	20.00	24.00
VAP6.3X70	6,3 X 70	0.22	0.26	22.00	26.40

TIREFOND (BOIS)



CODE	DIMENSION	PRIX HT A L'UNITÉ	PRIX TTC A L'UNITÉ	PRIX HT LES 100	PRIX TTC LES 100
TF6X40	06 X 040	0.05	0.06	5.00	6.00
TF6X50	06 X 050	0.07	0.08	7.00	8.40
TF6X60	06 X 060	0.09	0.11	9.00	10.80
TF6X070	06 X 070	0.11	0.13	11.00	13.20
TF6X80	06 X 080	0.13	0.16	13.00	15.60
TF6X90	06 X 090	0.15	0.18	15.00	18.00
TF8X40	08 X 040	0.09	0.11	9.00	10.80
TF8X60	08 X 060	0.12	0.14	12.00	14.40
TF8X80	08 X 080	0.15	0.18	15.00	18.00
TF8X100	08 X 100	0.16	0.19	16.00	19.20
TF8X120	08 X 120	0.18	0.22	18.00	21.60

ROUES POUR PORTAIL

Roue sans support

DESIGNATION	CODE	Ø	PRIX HT	PRIX TTC
Roue <u>Gorge U</u>	HU8	80	7.50	9.00
	HU1	100	9.75	11.70
	HU12	120	16.00	19.20



ROUE GORGE U

Roue avec support GORGE V

DESIGNATION	CODE	Ø	Roulement	PRIX HT	PRIX TTC
Roue à support <u>Gorge V</u>	GV8	80	1	9.00	10.80
	GV1	100	1	12.00	14.40
	GV12	120	2	20.00	24.00

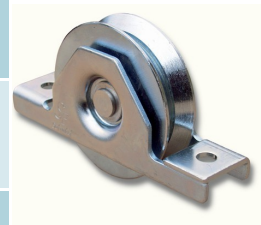

Roue avec support GORGE U

DESIGNATION	CODE	Ø	Roulement	PRIX HT	PRIX TTC
Roue à support <u>Gorge U</u>	GU8	80	1	9.00	10.80
	GU1	100	1	12.00	14.40
	GU12	120	2	20.00	24.00

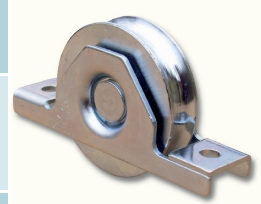

ROULETTES DE MANUTENTION

Qualité Standard

- FIXE

CODE		PVHT	PVTTC
ROU100F	Ø100	5.50	6.60



- PIVOTANTE

CODE		PVHT	PVTTC
ROU101P	Ø100	7.50	9.00



- PIVOTANTE A FREIN

CODE		PVHT	PVTTC
ROU102PF	Ø100	9.50	11.40



FOND BOMBÉ à souder en acier noir



CODE	Dimension	PVHT	PVTTC
FB26.9	26.9X2.3	1.10	1.32
FB33.7	33.7X2.3	1.13	1.36
FB42.4	42.4X2.6	1.18	1.42
FB48.3	48.3X2.6	1.30	1.56
FB60.3	60.3X2.9	1.80	2.16
FB76.1	76.1X2.9	2.15	2.58

COURBE 90° à souder en acier noir



CODE	Dimension	PVHT	PVTTC
C21.3	21.3 X 2	1.76	2.11
C26.9	26.9 X 2.3	1.94	2.33
C33.7	33.7 X 2.3	2.06	2.47
C42.4	42.4 X 2.6	2.20	2.64
C48.3	48.3 X 2.6	2.94	3.53
C60.3	60.3 X 2.9	3.50	4.20
C76.1	76.1 X 2.9	5.44	6.53
C101.6	101.6 X 3.6	10.56	12.67

CHAPEAU pointe de diamant en acier à souder

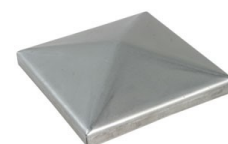

CODE	Dimensions	PVHT	PVTTC
CHAP40	40 X 40	0.96	1.15
CHAP80	80 X 80	1.65	1.98
CHAP100	100 X 100	2.19	2.63
CHAP150	150 X 150	4.14	4.97

CAPUCHON POUR TUBE CARRE



CODE	Dimension	PVHT	PVTTC
CAP20X20	20 X 20	0.16	0.19
CAP25X25	25 X 25	0.20	0.24
CAP30X30	30 X 30	0.24	0.29
CAP35X35	35 X 35	0.40	0.48
CAP40X40	40 X 40	0.56	0.67
CAP45X45	45 X 45	0.68	0.82
CAP50X50	50 X 50	0.72	0.86
CAP60X60	60 X 60	1.38	1.66
CAP80X80	80 X 80	2.80	3.36
CAP100X100	100 X 100	3.50	4.20
CAP120X120	120 X 120	9.00	10.80

CAPUCHON POUR TUBE ROND



CODE	Dimension	PVHT	PVTTC
EAR20	Ø20	0.17	0.20
EAR25	Ø 25	0.20	0.24
EAR30	Ø 30	0.24	0.29
EAR33.7	Ø 33.7	1.46	1.75
EAR40	Ø 40	0.44	0.53
EAR42.4	Ø 42.4	2.30	2.76
EAR45	Ø 45	0.64	0.77
EAR48.3	Ø 48.3	3.70	4.44
EAR50	Ø 50	0.88	1.06
EAR60	Ø 60	0.92	1.10
EAR76	Ø 76	2.22	2.66

CAPUCHON POUR TUBE RECTANGLE



CODE	Dimension	PVHT	PVTTC
ETREC 35	35 X20	0.32	0.38
ETREC40X20	40 X 20	0.40	0.48
ETREC40	40 X 27	0.48	0.58
ETREC50	50 X 30	0.66	0.79
ETREC60	60 X 30	0.84	1.01
ETREC80	80 X 40	1.16	1.39
ETREC100	100 X 50	1.50	1.80

CHEVILLE FIX3 SPIT



CODE	Ø perçage en mm	Ep maxi pièce à fixer	Longueur Cheville (mm)	Profondeur de perçage (mm)	Charge indicative	PVHT	PVTTC
FIX8	8	20	70	50	610	0.44	0.53
FIX10	10	15	75	60	850	0.60	0.72
FIX12	10	25	100	75	1260	1.06	1.27
FIX16	16	30	125	95	1720	2.74	3.29

CODE	Descriptif	PVHT	PVTTC
NYL8	Cheville nylon Ø8	0.07	0.08
NYL10	Cheville nylon Ø10	0.18	0.22
CHAUSCEL	Tamis d'injection H.16X85	1.06	1.27



PISTOLET SQUELETTE



CODE : **PSQUE**

Prix HT : 5.98€

Prix TTC : 7.18€

PISTOLET MANUEL



CODE : **PMAN**

Prix HT : 54.35€

Prix TTC : 65.22€

SCELLEMENT CHIMIQUE « GRIS » OU « PIERRE » 300ML OU 380ML



CODE	COULEUR	Contenance	PVHT	PVTTC
SCELG	GRIS	300ML	10.20	12.24
SCELG3	GRIS	380ML	10.20	12.24
SCELP	PIERRE	300ML	10.20	12.24
SCELP3	PIERRE	380ML	10.20	12.24

FORET TIVOLY PRO



FURIUS Métal HSS FUSIO taillé meulé cylindrique

Durée de vie X3

Perce : Métaux résistants, aciers de construction, profilé.

CODE	Ø		PVHT	PVTTC
F4	4	Etui x2	4.79	5.75
F4.5	4.5	Etui x2	5.15	6.18
F5	5	Etui x2	5.49	6.59
F6	6	Etui x1	3.91	4.69
F8	8	Etui x1	6.35	7.62
F8.5	8.5	Etui x1	6.62	7.94
F10	10	Etui x1	8.53	10.24
F10.5	10.5	Etui x1	11.11	13.33
F11	11	Etui x 1	13.39	16.07
F12	12	Etui x1	15.23	18.28
F12.5	12.5	Etui x1	16.51	19.81
F13	13	Etui x1	17.03	20.44
FR14	14	Etui x1	22.77	27.32
FR15	15	Etui x1	24.75	29.70

COFFRETS FORETS



COFFRET DE 25 FORETS HSS TAILLÉ MEULÉ

Jeu de 25 forets DIN 338 type N

- HSS taillé meulé
- Affutage en croix
- Angle de pointe 118° , de 1 à 13mm par 0.5mm

CODE: HAHSS 61.67€HT / 74.00€TTC



COFFRET DE 25 FORETS COBALT 5%

Jeu de 25 forets cobalt 5% DIN338 type N

- HSS COBALT 5% taillé meulé
- Affutage en croix
- Angle de pointe 135° , de 1 à 13mm par 0.5mm

CODE: HACO 81.67 €HT / 98.00€TTC

VIS A BOIS



CODE	DIMENSIONS	PRIX HT LA BOITE	PRIX TTC LA BOITE
TOR4.5X70 (BTE DE 250)	4.5X70	14.36	17.23
TOR6X70 (BTE DE 150)	6.0X70	11.46	13.75
TOR6X160 (BTE DE 100)	6.0X160	32.50	39.00

OFFRE SPÉCIALE

**1 CARTON DE 4 BIDONS ACHETÉ
=
1 DISTRIBUTEUR OFFERT**



CARTOUCHE SAVON 4 Litres
pour DISTRIBUTEUR ARMA

Code : ARMAS

25.90€ HT 31.08€ TTC



DISTRIBUTEUR SAVON ARMA

Code : ARMAD

65.00€ HT 78.00€ TTC

Matériel BOSH



Meuleuse 900watts

[Code : MEUL900](#)

120.83€ HT

145.00€ TTC



Meuleuse 1400 watts diamètre: 125

[Code : MEUL1400](#)

124.17€ HT

149.00€ TTC



Meuleuse 2200 watts diamètre: 230

[Code : MEUL2200](#)

158.33€ HT

190.00€ TTC

JEU CHARBON MEULEUSE

[Code : CHAME](#)

30.00€ HT

36.00€ TTC

ETAU 150mm

Construction en alliage solide, fuseau facile à manier, Rainure de fixation, mâchoire de serrage en acier avec profil sur la surface de serrage, grande capacité de serrage...

Caractéristiques techniques

Diamètre : 150 mm

Dimension de serrage: 135mm

Trou: 185mm

Poids: 6,55 Kg

CODE : ETAU1

49.95€ HT **59.94€ TTC**



COFFRET BOSCH DE 11 SCIES TREPANS PROGRESSOR UNIVERSEL

Ø20,22,25,32,40,44,51,61,68 et 76mm / 8% Cobalt + adaptateur Power Change 12mm pour un changement facile du trépan + 2 forets de centrage HSS.G

CODE : C11ST PVHT : 195.00€ **PVTTC : 234.00€**



Serre-joint à levier 200mm

CODE : SERJ

24.92€ HT **29.90€ TTC**



VOLUTEUSE

CODE : SBG30

375.00€ HT **450.00€ TTC**



SCIE A RUBAN FLEX PORTABLE

CODE : SARFLEX

458.33€ HT **550.00€ TTC**

LAME POUR SCIE RUBAN SARFLEX

CODE : LAME

22.67€ HT **27.20€ TTC**

TOURET «BRICOLAGE»

Marque : FEMI



DESCRIPTIF

MOTEUR	MEULE	BANDE
230 V - 450 W	Ø 200 x l.20 mm	L.680 x l.50mm

CODE : TOURET

115.83€ HT 139.00€ TTC



Lot de 5 bandes L.680 X l.50mm

CODE : BANDE

37.50€ HT 45.00€ TTC

CODE: BANDEG36 (GRAIN 36)

2.12€ HT 2.54€ TTC

CODE: BANDEG120 (GRAIN 120)

1.92€ HT 2.30€ TTC

PERCEUSE A COLONNE

Marque : FOX



MOTEUR	CARACTERISTIQUES	VITESSES	MANDRIN	CAPACITE PERCAGE	CONE MORSE	POIDS
230 V - 360 W	d'établi H.540 mm	5 (500/2500min-1)	13mm	Bois 13mm Métal 13mm	B16	17 KG

CODE : PERC

124.17€ HT

149.00€ TTC



	<p>PUSH-CLICK Vitesse d'avancement de la coupe à 4 positions avec sélecteur mécanique</p>
	<p>INTERRUPTEUR d'arrêt automatique à la fin de la coupe</p>
	<p>BOUTON DE SECURITE pour arrêter la coupe</p>

ABS 105

SERIE PROFESSIONNELLE





ABS 105						
Données techniques						
 WATT						
950	1335x13x0,65	8/12°	30 ÷ 80	730x390x500	17	
Lame bimétal au cobalt de série Moteur monophasé 230Watt - Hz 50						
Capacités de coupe						
						
0°	100x85 mm	105 mm	95x95 mm			
45°	65x60 mm	65 mm	65x65 mm			



Made in Italy

CODE : ABS105

595.00€ HT

714.00€ TTC

Coffret écrous zingués blanc

Code : COF901

48.00€ TTC

Coffret comprenant 765 écrous HU DIN934 zingué blanc :

90 de diamètre 3 mm - 100 de diamètre 4 mm - 105 de diamètre 5 mm - 225 de diamètre 6 mm -
120 de diamètre 8 mm - 45 de diamètre 10 mm - 55 de diamètre 12 mm - 25 de diamètre 16 mm

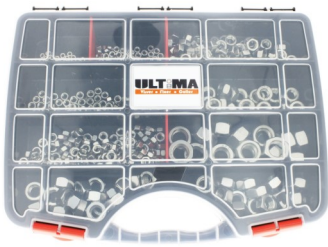

Coffret de vis tête hexagonale zinguée

Code : COF801

48.00€ TTC

Coffret comprenant 172 vis tête hexagonale zinguée blanche classe 8.8 DIN933 :

30 de diamètre 6.0 X 16 mm - 25 de diamètre 6.0 X 20 mm - 25 de diamètre 6.0 X 25 mm - 15 de diamètre 6.0 X 30 mm -
10 de diamètre 6.0 X 40 mm - 10 de diamètre 6.0 X 50 mm - 25 de diamètre 8.0 X 20 mm - 12 de diamètre 8.0 X 30 mm -
12 de diamètre 8.0 X 40 mm - 8 de diamètre 10.0 X 20 mm



Coffret de vis autoperceuse tête fraisée 6 lobes



Code : COF154

69.00€ TTC

Coffret comprenant 1605 vis autoperceuse tête fraisée 6 lobes interne zinguée blanche :

250 de diamètre 3.5 X 16 mm - 200 de diamètre 3.9 X 19 mm - 150 de diamètre 3.9 X 25 mm - 150 de diamètre 4.2 X 19 mm -
150 de diamètre 4.2 X 25 mm - 85 de diamètre 4.2 X 32 mm - 100 de diamètre 4.2 X 38 mm - 350 de diamètre 4.8 X 25 mm -
100 de diamètre 4.8 X 38 mm - 70 de diamètre 4.8 X 50 mm



Coffret de vis tête fraisée zinguée

Code : COF121

48.00€ TTC (Bois)



Coffret comprenant 1055 vis têtes fraisées pointe cutting cruciforme zinguée blanche :

150 de diamètre 4.0 X 20 mm - 150 de diamètre 4.0 X 25 mm - 100 de diamètre 4.0 X 30 mm
100 de diamètre 4.0 X 35 mm - 300 de diamètre 4.0 X 40 mm - 50 de diamètre 5.0 X 40 mm
50 de diamètre 5.0 X 50 mm - 40 de diamètre 5.0 X 60 mm - 65 de diamètre 5.0 X 70 mm - 50 de diamètre 5.0 X 80



Coffret rondelles M

Code : COF912

48.00€ TTC

Coffret comprenant 855 rondelles M zinguées blanche :

105 de diamètre 4mm - 105 de diamètre 5mm - 125 de diamètre 6mm - 220 de diamètre 8mm -
115 de diamètre 10mm - 105 de diamètre 12mm - 80 de diamètre 16mm



Coffret vis pentures bichromatée

Code : COF131

65.00€ TTC

Coffret comprenant 325 vis pentures 6 lobes interne bichromatée :

- 50 de diamètre 6.0 X 20 mm.
- 50 de diamètre 6.0 X 25 mm.
- 40 de diamètre 6.0 X 30 mm.
- 35 de diamètre 6.0 X 35 mm.
- 25 de diamètre 6.0 X 45 mm.
- 50 de diamètre 6.0 X 50 mm.
- 35 de diamètre 6.0 X 60 mm.
- 20 de diamètre 6.0 X 70 mm.



Coffret de 7 Forets taraudeurs pro Marque : Hanger

Code : COF7

68.00€ TTC

Coffret 7 pièces comprenant :

6 forets taraudeurs M3-4-5-6-8-10
1 porte embout universel

